

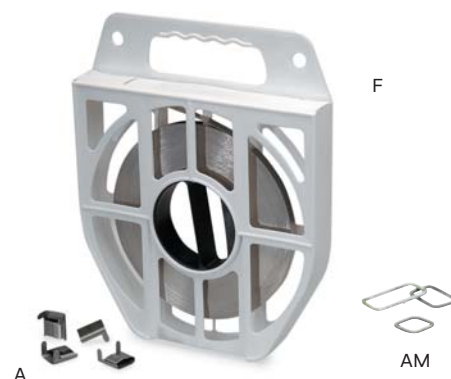



Conessioni / Connettori isolati a perforazione



11109 F / A / AM



Reggetta metallica e accessori

La reggetta metallica Z12 CN 1707 e i suoi accessori sono utilizzati principalmente per fissare e sostenere elementi in diverse applicazioni industriali e di costruzioni. Può essere tagliata alla lunghezza desiderata e viene utilizzata in combinazione con accessori come chiusure e attrezzi di tensione per garantire carichi o strutture. Incorpora un dispenser che facilita il trasporto e la maneggevolezza.



Codice	Rif.	Larghezza x Spessore (mm)	Lunghezza (m)	 x 1	 Borsa	 Scatola
371100	F-104	10x0,4	50	1,600	-	1
371110	F-107	10x0,7	50	2,700	-	1
371120	F-204	20x0,4	50	3,400	-	1
371130	F-207	20x0,7	50	5,800	-	1

Codice	Rif.	Larghezza (mm)	 x 1	 Borsa	 Scatola
371140	A-100	10	0,500	100	-
371150	A-200	20	0,900	100	-

Codice	Rif.	Dimensioni (mm)	 x 1	 Borsa	 Scatola
371160	AM-25	25x25	1,400	100	-
371170	AM-40	25x40	1,900	100	-
371180	AM-60	25x60	2,450	100	-